



900 MHz. No-Battery Wireless Door Control System



The New Wireless Superpower Wireless Signal Powered by Pushing the Switch!

Kinetic by Camden™ is an advanced 900 MHz. wireless system that uses the energy created by the operation of the switch to power the wireless transmitter. Kinetic by Camden™ avoids the need to provide power or batteries, saving installation and maintenance costs.

Kinetic by Camden™ is the only 'power harvesting' wireless system to feature an ultra-compact receiver (easily installed in automatic door operator cabinets), with field selectable momentary, delayed or latching relay operation, and range adjustability.

Features

- Huge Savings in Installation and Maintenance Costs
- Battery-less Switch Operation
- No-Battery Maintenance
- Environmentally Friendly - Eliminates the Disposal of Batteries
- Smooth Switch Operation, ADA Compliant Activation, Using 3.4 lbs Force Maximum
- Advanced CM-RX-90V2 Wireless Receiver is Compatible with both Lazerpoint RF™ and Kinetic by Camden™ Wireless Systems, Switch Selectable
- No-Battery Wireless Transmitter may be ordered as part of Camden CM-35, CM-40, CM-45, CM-46, CM-60 and CM-75 Series Push Plate Switches
- Compact Design Fits Standard Depth Mounting Boxes



Applications

Kinetic by Camden™ No-battery Wireless Systems are compatible with all brands of automatic door operators and are designed to provide reliable door activation in any commercial, industrial or institutional application.

These systems are designed for indoor or outdoor applications. For switches directly exposed to rain or snow, a water tight switch option is recommended.

SPECIFICATIONS

Push Plate Switch & No-Battery Transmitter

WIRELESS FREQUENCY:	900 MHz. Fixed Frequency
RANGE OPEN AIR:	Up to 300ft.
IN OPERATOR HEADER:	Up to 70 ft.
TEMP RATING:	-40°F to 185°F (-40°C to 85°C)
WATER TIGHT OPTION:	Yes
DIMENSION:	1-1/2" (38mm) Box Depth Required

Compatible Receivers

VOLTAGE:	12/24V, AC/DC
OUTPUT:	CM-RX-90: (1) SPDT relay, 3 modes
CURRENT DRAW:	CM-RX-90: 23mA - 43mA
TEMP RATING:	Alkaline: 32°F to 122°F (0°C to 50°C) Lithium: -40°F to 122°F (-40°C to 50°C)
TIME DELAY:	CM-RX-90: 1-30 seconds
RECEIVER DIMENSIONS:	CM-RX-90: 3-1/2"H x 1-1/2"W x 13/16"D (89mm x 38mm x 21mm)

ORDERING INFORMATION

Wireless Receivers



CM-RX-90
V2 Lazerpoint RF™ and Kinetic™
Compatible Single Relay Receiver

CM-RX-90 RECEIVER

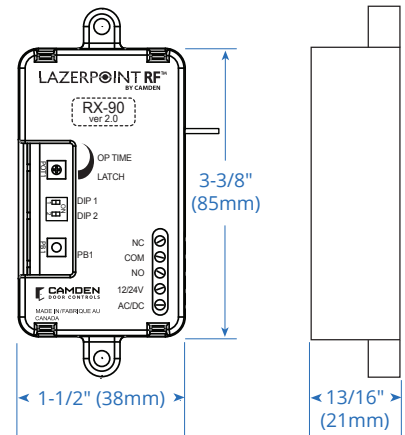

Front View

Side View

ORDERING INFORMATION

Kinetic™ Push Plate Switch Series Models

 <p>CM-25K 1-3/4" Width, narrow push plate switch, vertical mounting, brush stainless steel finish</p>	 <p>CM-26CBK 1-3/4" Width narrow push plate switch, blue with white graphics, exposed screws</p>	 <p>CM-35K 2" Width narrow push plate switch, vertical mounting, brushed stainless steel finish</p>	 <p>CM-35NK 2" Width narrow push plate switch, single gang back plate, brushed stainless steel finish</p>	 <p>CM-40K 4-1/2" Round push plate switch, brushed stainless steel finish</p>
 <p>CM-41K 4-1/2" Round push plate switch, brushed stainless steel finish</p>	 <p>CM-45K 4-1/2" Square push plate switch, concealed screws, brushed stainless steel finish</p>	 <p>CM-46K 4-1/2" Square push plate switch, exposed screws, brushed stainless steel finish</p>	 <p>CM-46CBK 4-1/2" Square push plate switch, exposed screws, aluminum, blue paint finish</p>	 <p>CM-60K 6" Round push plate switch, brushed stainless steel finish</p>
<p>CM-7536K - 6" 36" Column™ push plate switch, anodized aluminum, optional bronze/blue finish</p> 	<p>CM-7536SSK - 6" 36" Column™ push plate switch, anodized aluminum, stainless steel finish</p> 	<p>CM-7436K - 4.5" 36" Column™ push plate switch, anodized aluminum, option for bronze finish</p> 		

FACEPLATE GRAPHIC OPTIONS













<p>CM-XX/1</p> 	<p>CM-XX/2</p> 	<p>CM-XX/A2</p> 	<p>CM-XX/2AL</p> 
<p>CM-XX/2AR</p> 	<p>CM-XX/3</p> 	<p>CM-XX/3F</p> 	<p>CM-XX/4</p> 
<p>CM-XX/A4</p> 	<p>CM-XX/4AL</p> 	<p>CM-XX/4AR</p> 	<p>CM-XX/4F</p> 
<p>CM-XX/8</p> 	<p>CM-XX/8B</p> 	<p>CM-XX/8D</p> 	<p>CM-XX/8F</p> 



KINETIC BY CAMDEN™ 900 MHZ. WIRELESS SWITCH KITS

Kinetic by Camden™ 900MHz. No-battery wireless system kits include (2) push plate switches with built-in Kinetic wireless transmitters, (2) surface mount boxes/enclosures, and (1) CM-RX-90 single relay receiver.

Kits can be configured using any graphic, architectural finish or weatherproof option. Also available for round switches mounted on in-wall single gang boxes.

SWITCH KIT MODELS				
(COMPLETE LIST AVAILABLE ON CAMDENCONTROLS.COM)				
CM-RFK35/4				(2) CM-35K 2" x 4" Single Gang Switches, Wheelchair Symbol & Text (2) CM-34BL Surface Mount Boxes (1) CM-RX-90 Receiver
CM-RFK45/4				(2) CM-45K 4-1/2" Square Switches, Wheelchair Symbol & Text (2) CM-43CBL Surface Mount Boxes (1) CM-RX90 Receiver
CM-RFK46CB/4				(2) CM-46CBK 4-1/2" Square Switches, Wheelchair Symbol & Text (2) CM-43CBL Surface Mount Boxes (1) CM-RX90 Receiver
CM-RFK60/4				(2) CM-69SER Surface Round, Extra Deep, for Kinetic™ CM60K & SureWave™ 'R' suffix 6" round switches (2) CM-60K 6" Round Push Plate Switches, Wheelchair Symbol & Text (1) CM-RX-90V2 Receiver. Mounts on Single Gang In-Wall Electrical Box

SWITCH KIT OPTIONS				
ARCHITECTURAL FINISHES				
				
-AB Add 'AB' to product # for (2) antique brass finish (US5 / 609)	-SB Add 'SB' to product # for (2) satin brass finish (US4 / 606)	-OB Add 'OB' to product # for (2) oil rub bronze finish (US10B / 613)	-PB Add 'PB' to product # for (2) polished brass finish (US3 / 605)	
WATERPROOFING	WT Add suffix to any RFL kit (2) 'WT' water tight			